

How to Rebuild Pontiac 8s Updated Edition: Your Guide to Classic Car Restoration

: The Pontiac 8s Legacy

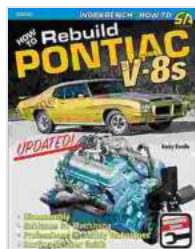

How to Rebuild Pontiac V-8s - Updated Edition

(Cartech) by Randy Taguchi

★★★★☆ 4.8 out of 5

Language : English

File size : 32377 KB

Text-to-Speech : Enabled

Enhanced typesetting : Enabled

Print length : 152 pages



For decades, the Pontiac 8s has been a symbol of American muscle and automotive innovation. From the roaring 1950s to the iconic 1970s, these legendary cars have captured the hearts of enthusiasts around the globe. Now, with the updated edition of "How to Rebuild Pontiac 8s," you can delve into the intricate process of restoring one of these timeless classics.

Chapter 1: Engine Overhaul

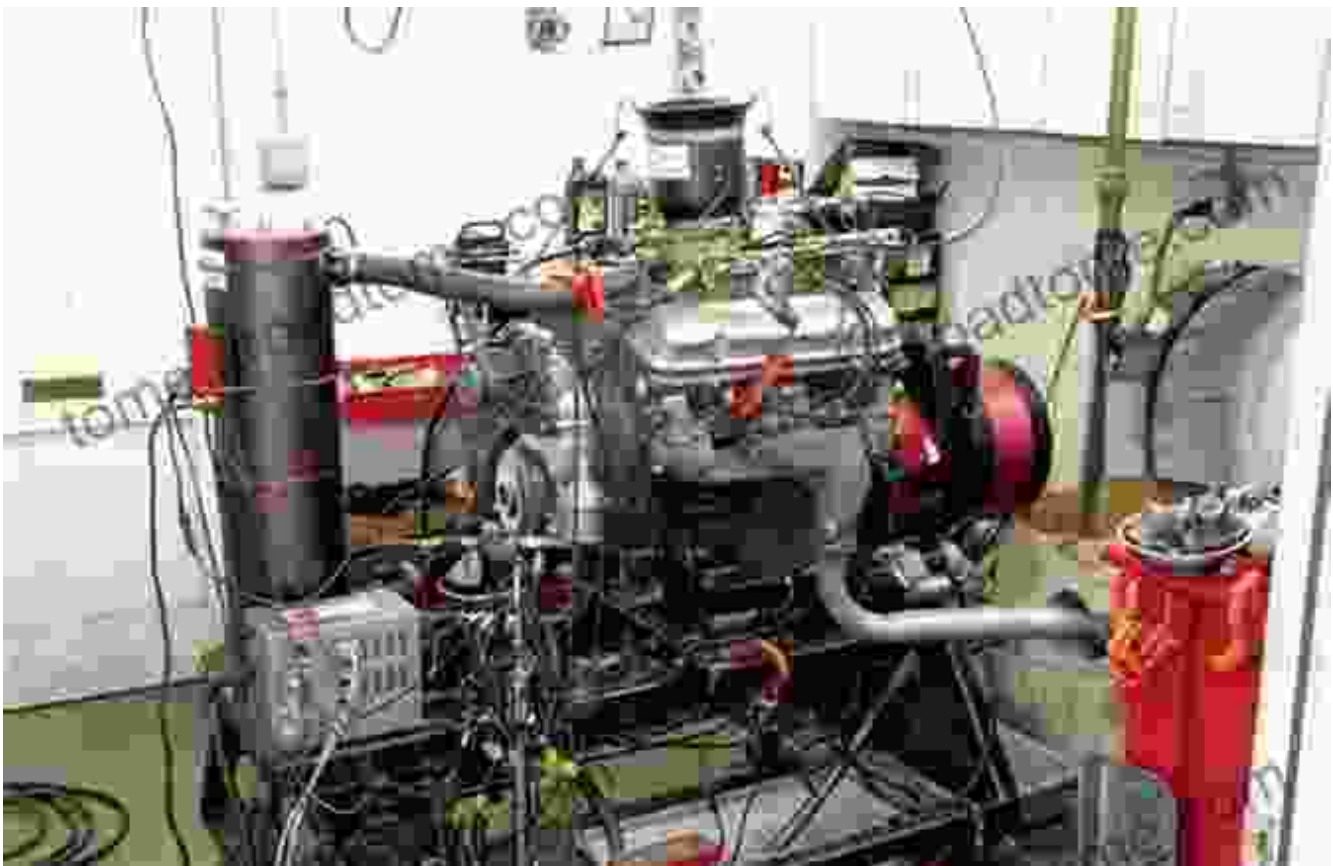

At the heart of every Pontiac 8s lies its powerful engine. "How to Rebuild Pontiac 8s Updated Edition" provides step-by-step instructions for

dismantling, inspecting, and rebuilding every component of your engine. From timing chains to camshafts, you'll learn the techniques and secrets to revitalizing the beating heart of your classic car.

Chapter 2: Transmission Rejuvenation

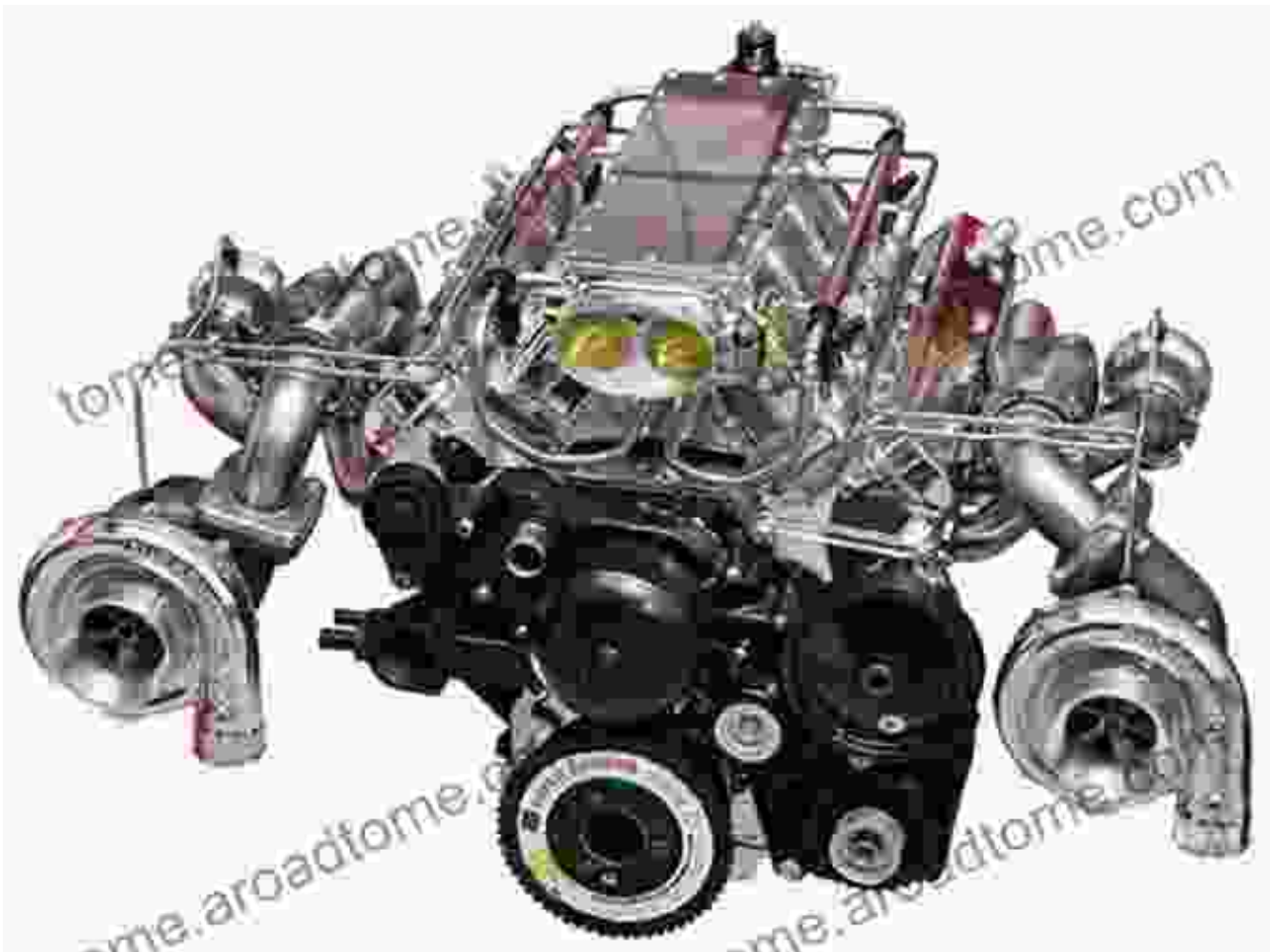

A smooth and responsive transmission is crucial for a satisfying driving experience. In this chapter, you'll explore the intricacies of rebuilding manual and automatic transmissions for your Pontiac 8s. Whether you're dealing with worn gears or faulty solenoids, the book guides you through the process of diagnosing and repairing these complex systems.

Chapter 3: Suspension Reinstatement

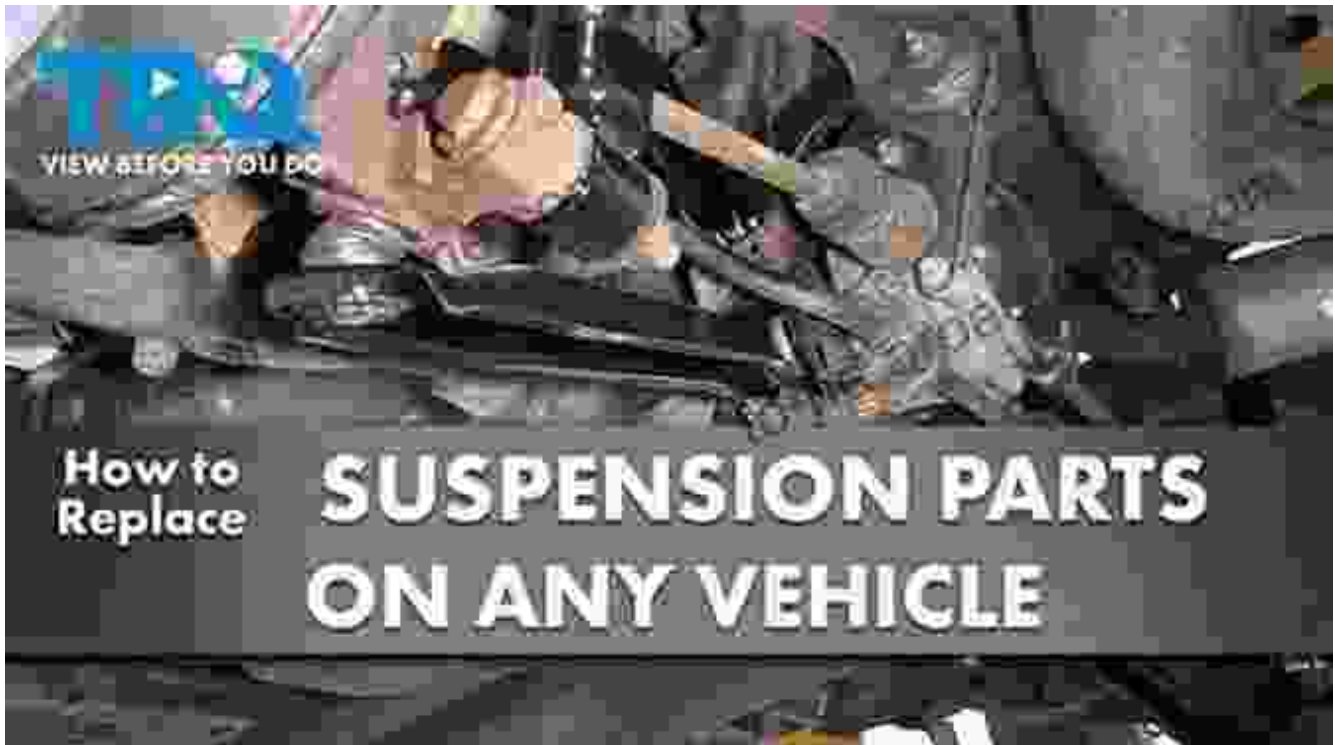

A solid suspension ensures stability, handling, and comfort on the road. "How to Rebuild Pontiac 8s Updated Edition" covers everything from rebuilding coil springs and shocks to replacing control arms and ball joints. You'll learn how to restore the original handling characteristics of your Pontiac 8s and make it a joy to drive.

Chapter 4: Brake Restoration



Safety is paramount when it comes to classic cars. This chapter provides comprehensive guidance on rebuilding and upgrading your Pontiac 8s' braking system. You'll learn how to diagnose problems, replace worn components, and adjust the brake pedal for optimal performance. Rest assured, you'll be equipped with the knowledge to ensure your classic car stops on a dime.

Chapter 5: Electrical System Revitalization

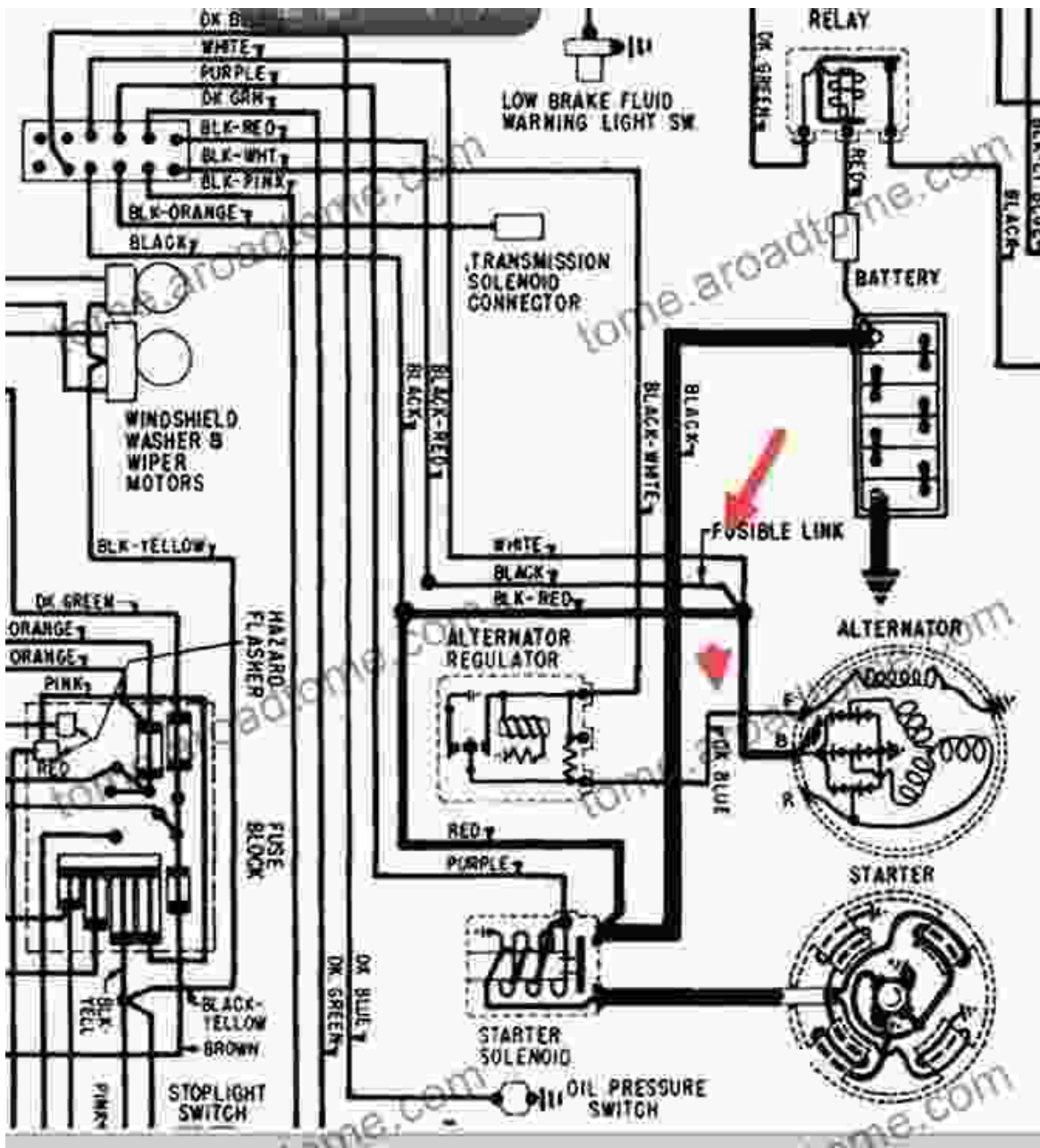

The electrical system is the backbone of any modern car. "How to Rebuild Pontiac 8s Updated Edition" takes you on a journey through the wiring diagrams and components of your vehicle. You'll learn how to troubleshoot electrical problems, replace damaged wires, and upgrade your charging and starting systems to ensure reliable performance.

Chapter 6: Interior Restoration



The interior of your Pontiac 8s is where you spend your time behind the wheel. This chapter provides detailed instructions for restoring the upholstery, dashboard, and seats. Whether you're dealing with torn seats or faded paint, you'll learn the techniques to bring the interior of your classic car back to its former glory.

Chapter 7: Upgrades and Modifications

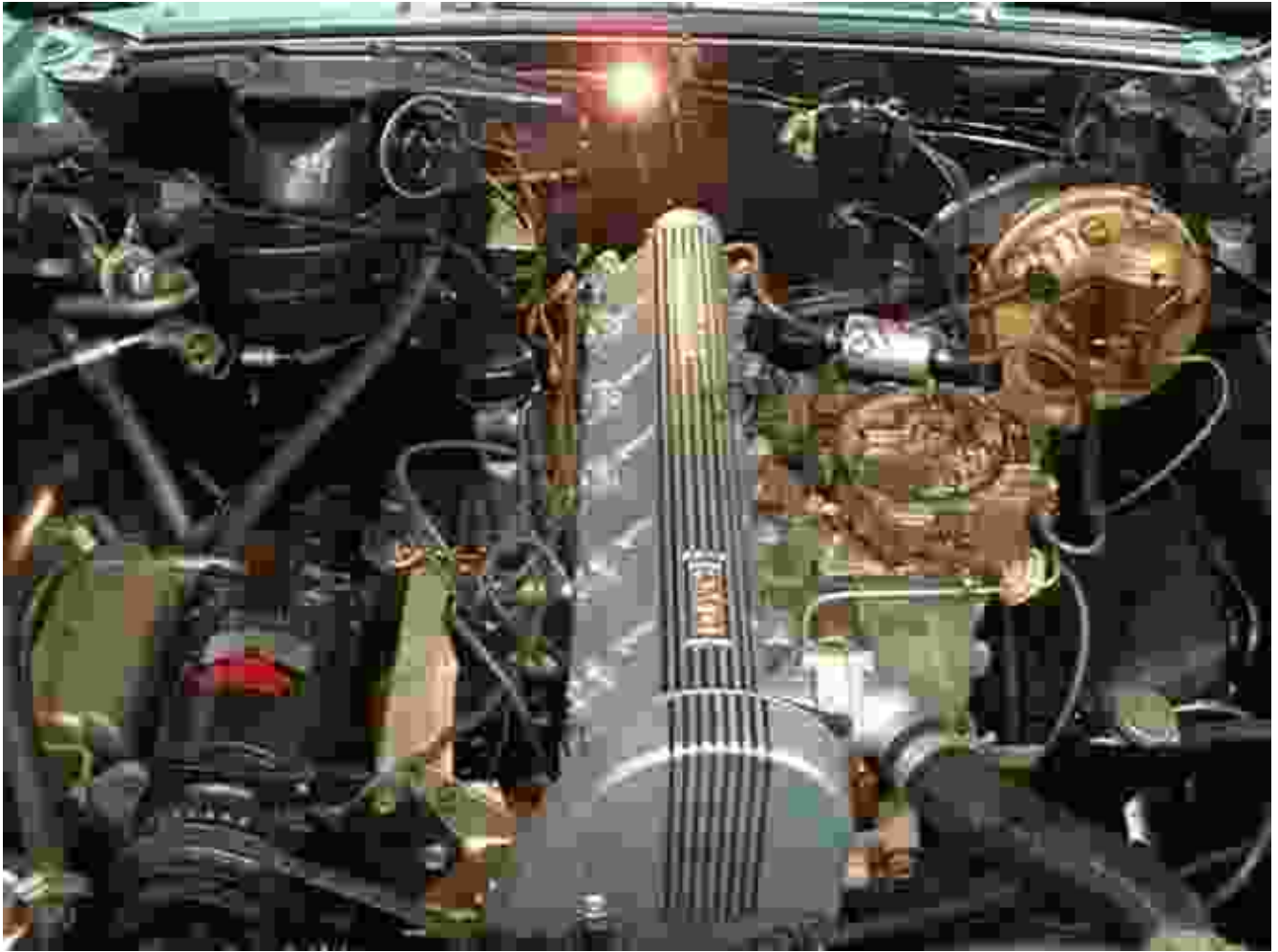

For those who desire to enhance the performance and appearance of their Pontiac 8s, this chapter explores various upgrades and modifications. From installing fuel injection systems to upgrading the suspension, you'll discover the possibilities for customizing your classic car to meet your specific needs and preferences.

: Your Pontiac 8s Reborn



As you complete each chapter of "How to Rebuild Pontiac 8s Updated Edition," you'll not only restore your classic car but also delve into the rich history and legacy of American automotive craftsmanship. With each turn of the page, you'll gain invaluable knowledge and a deeper appreciation for the iconic Pontiac 8s. Whether you're a seasoned mechanic or a first-time enthusiast, this comprehensive guide will empower you to embark on the extraordinary journey of rebuilding your Pontiac 8s to its former glory.

Free Download Your Copy Today

Don't wait any longer to embark on the adventure of rebuilding your Pontiac 8s. Free Download your copy of "How to Rebuild Pontiac 8s Updated

Edition" today and unlock the secrets to restoring one of the most iconic classic cars of all time.

Free Download Now

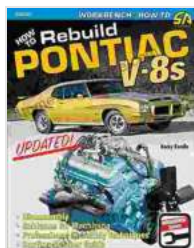

How to Rebuild Pontiac V-8s - Updated Edition

(Cartech) by Randy Taguchi

★★★★☆ 4.8 out of 5

- Language : English
- File size : 32377 KB
- Text-to-Speech : Enabled
- Enhanced typesetting : Enabled
- Print length : 152 pages
- Screen Reader : Supported

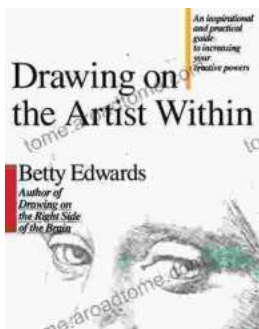

Unleash Your Inner Artist: An Immersive Journey with "Drawing On The Artist Within"

Embark on an Artistic Odyssey to Discover Your Creative Potential In the realm of art, true mastery lies not solely in technical...

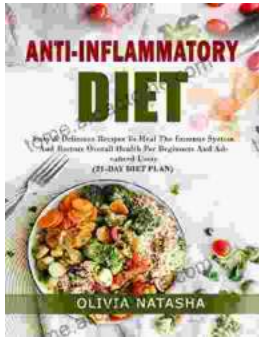

Easy Delicious Recipes To Heal The Immune System And Restore Overall Health For A Thriving, Energetic Life

: The Cornerstone of Immunity The human body is an intricate symphony of interconnected systems, each playing a vital role in maintaining our...